

VARIOS MAJOR

Modular System LED Downlight

Varios Major Modular System is the next generation in accent down lighting. Introducing the high performance of LED with the ultimate flexibility of interchangeable components thus creating the ability to form ambiance and drama which is ideal for a diverse range of applications. Designed to be a seamless transition from traditional light sources whilst harmonising design concepts.

VARIOS MAJOR

Modular System LED Downlight



Features

- Select Trim + Module(s) + Driver (1 per Module) = Complete Fitting
- Die-cast body with a drop forge heatsink
- Optics 20°/40°, variable outputs and styles.
- Range available in 2 styles and multiple combinations (single, double triple and single round option)
- Toolless operation. Quick connect plugs
- Multiple optics (fixed head), outputs and styles
- Available in 3000K and 4000K colour temperature
- Bidirectional adjustment
- Average rated Lamp design life 50000hrs / 70%
- Dimmable - (refer to the driver platform) operates from the common driver platform
- One of a family of 8 trim sizes with 15/26/42 wattage options depending on driver and fixture size
- 3 years warranty

Applications

- Designed for retail fit out, commercial areas, transit corridors, break out areas, lobby's, common

Specifications

	Varios 42W LG Module	Varios 42W DG Module
Colour temp	3000K and 4000K	3000K and 4000K
Lumen Output	See Chart	See Chart
CRI	>90	>90
Macadams step	3 SDCM	3 SDCM
Beam distribution	Symmetric	Symmetric
Default beam angle	20°/40°	20°/40°
Lumen maintenance	L70 50,000hrs	L70 50,000hrs
Control	REMOTE	REMOTE
Dimensions (module only)	Ø118 x H:131mm	Ø118 x H:160mm
Cutout	Refer to fixture selected	Refer to fixture selected
Min recessed depth	160mm	190mm
Power factor	0.9	0.9
Electrical rating	Class III	Class III

VARIOS MAJOR

Modular System LED Downlight

Driver & Module - Shallow Profile

26W	Required Component	
	Driver	26W
	DAD32F07001	Non-Dim
	DAD32D07001	DALI
	DAD32V07001	1-10V
		700mA*
* = Factory Default		

Series	Module selection	Description	Wattage	Lumens Initial	Lumens Exit	mA setting
	VAL118370201A	VARIOS MAJ 26W 3K LG 20D RF WH	26	2655	2567	700
	VAL118470201A	VARIOS MAJ 26W 4K LG 20D RF WH	26	2743	2652	700
	VAG118370201A	VARIOS MAJ 26W 3K DG 20D RF WH	26	2655	2567	700
	VAG118470201A	VARIOS MAJ 26W 4K DG 20D RF WH	26	2743	2652	700

Driver & Module - Deep Profile

40W	Required Component	
	Driver	42W
	DAD50F10501	Non-Dim
	DAD50D10501	DALI
	DAD50DV10501	1-10V
		1050mA*
* = Factory Default		

Series	Module selection	Description	Wattage	Lumens Initial	Lumens Exit	mA setting
	VAL118310401A	VARIOS MAJ 42W 3K LG 40D RF WH	42	2 x 3762	2 x 3567	1050
	VAL118410401A	VARIOS MAJ 42W 4K LG 40D RF WH	42	2 x 3762	2 x 3567	1050
	VAG118310401A	VARIOS MAJ 42W 3K DG 40D RF WH	42	2 x 3762	2 x 3567	1050
	VAG118410401A	VARIOS MAJ 42W 4K DG 40D RF WH	42	2 x 3762	2 x 3567	1050

Trim





Trim Selection	Trim Selection	Description	Cut-Out(mm)
	VAR1521	VARIOS MAJ RND FRM/TRM WHITE	143
	VAS1881	VARIOS MAJ X1 FRM/TRM WHITE	175 X 175
	VAD3421	VARIOS MAJ X2 FRM/TRM WHITE	175 X 320
	VAT4981	VARIOS MAJ X3 FRM/TRM WHITE	175 X 475

VARIOS MAJOR

Modular System LED Downlight

Create multiple options for greater effect in all applications.

Select Trim + Module(s) + Driver (1 per Module) = Complete Fitting

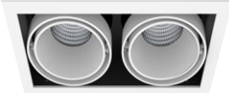
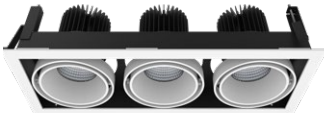
Trim	Module	Driver
		
		
		
		

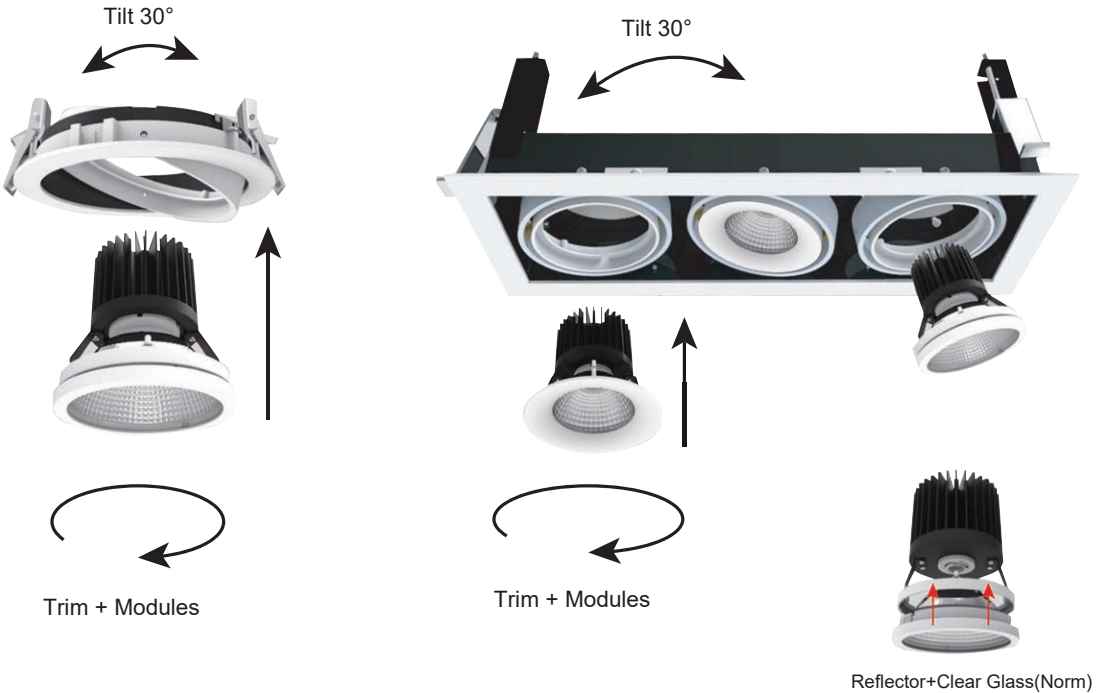

Technical Requirements

Round Single

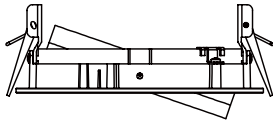

Cut out \varnothing 143mm 

Square Single

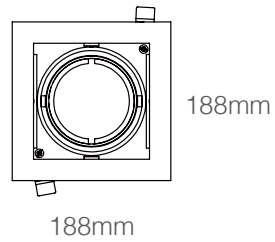
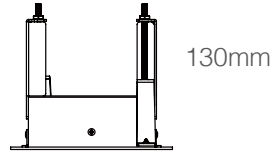

Cut out 175x175mm 

Twin

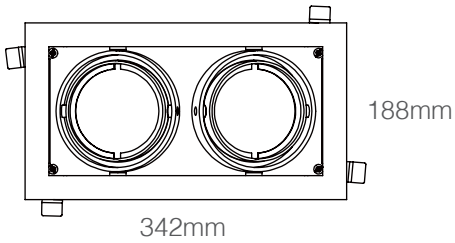
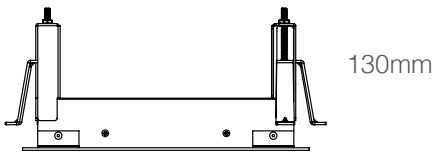

Cut out 320x175mm 

Triple

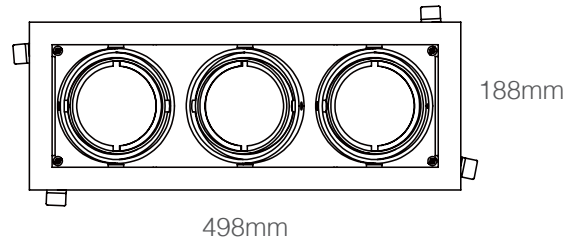
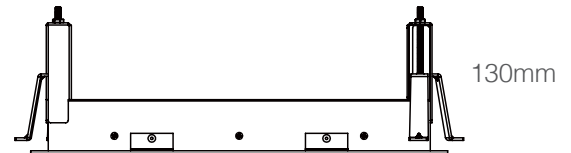

Cut out 475x175mm 

42W LG Module

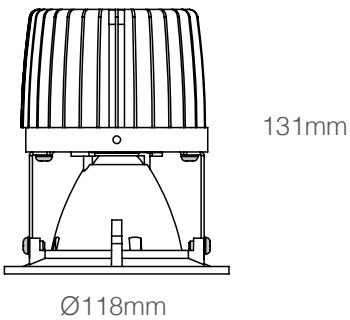

\varnothing 118mm

42W DG Module

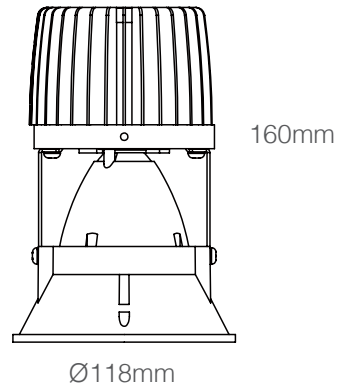

\varnothing 118mm

