

DALI Adaptive Phase Angle Dimming Device

Suitable for LED lighting and traditional sources



Designed in Australia to meet Australian Standards and installation conditions



1. Product Item

This guide provides installation and product specification information for the DALI Adaptive Phase Angle Dimming Device, item number **DOZ-DM-400W-01** and the included Load Bypass Device accessory (see page 6).

2. Important notes and safety information



Electric shock may result in serious injury or death. Follow all warnings in this guide and on the product while working in accordance with the latest electrical safety practices.

Connecting a Diginet DALI Adaptive Phase Angle Dimming Device to mains and/or a DALI Line must be carried out by a suitably qualified installer who must work in accordance with standard safety procedures for mains-powered electrical equipment.

There are no user serviceable parts inside this product. Do not attempt to disassemble or operate the device with any covers removed.

If you require information or assistance regarding the installation or operation of this product, contact Technical Services at Diginet Control Systems. Contact details are provided on the back cover of this guide and also at www.diginet.net.au

3. Product summary

The Diginet DALI Adaptive Phase Angle Dimming Device is designed for dimming up to 400W of connected lighting via DALI commands issued on a connected DALI line.

The device is capable of dimming up to 400W of LED lighting (see table on page 8 for further information).

The device is **not** suitable for use with Ceiling Sweep Fans, Exhaust Fans or any motor loads.

The device includes a large area for terminating all 1.5mm² or 2.5mm² double insulated cables (240Vac Active supply cable, switched load cable and DALI Line cables).

The device is fully tested to and complies with DALI standards IEC 62386.

4. Product Features

- Phase dimming of lighting loads via received DALI commands
- Capable of dimming lighting loads up to 400W
- Line powered – draws only 2mA from a DALI Line
- Two wire dimming device – No Neutral required. Only 240Vac Active and Load conductors
- Suitable for mounting in a ceiling void or via the included DIN rail mounting bracket
- DALI compliant (IEC Standard 62386-205, DALI Device Type 4)
- The phase dimmed output can be linked to a DALI Short Address
- The phase dimmed output is able to be allocated to up to 16 DALI Group Addresses and/or up to 16 DALI Scenes
- Short Address, Group Addresses and DALI Scenes are configured via Diginet **RPIX Integrator** software.

5. Mounting the DALI Adaptive Phase Angle Dimming Device

Surface mounting the DALI Adaptive Phase Angle Dimming Device

Two off, 6mm mounting holes are provided for mounting the device.



DIN rail mounting the DALI Adaptive Phase Angle Dimming Device

The device can optionally be mounted on standard DIN rail using the included DIN Rail mounting bracket, as shown below



1. Mount the optional mounting bracket onto DIN rail at the required location.



2. Lock into place by pushing up the black locking pin at the bottom of the bracket



3. Locate the device onto the two pins at the bottom mounting bracket



4. Push the top on the device onto the mounting bracket and clip into place

6. Connecting the device to a DALI Line

To operate correctly, the DALI Adaptive Phase Angle Dimming Device must be connected to both 240Vac mains power and a DALI Line powered by a DALI Power Supply. The DALI Power supply must be a device which has been designed to and meets the DALI standards. The Diginet DALI Power Supply, Item Number **DGLMPS01** (available separately) is recommended.

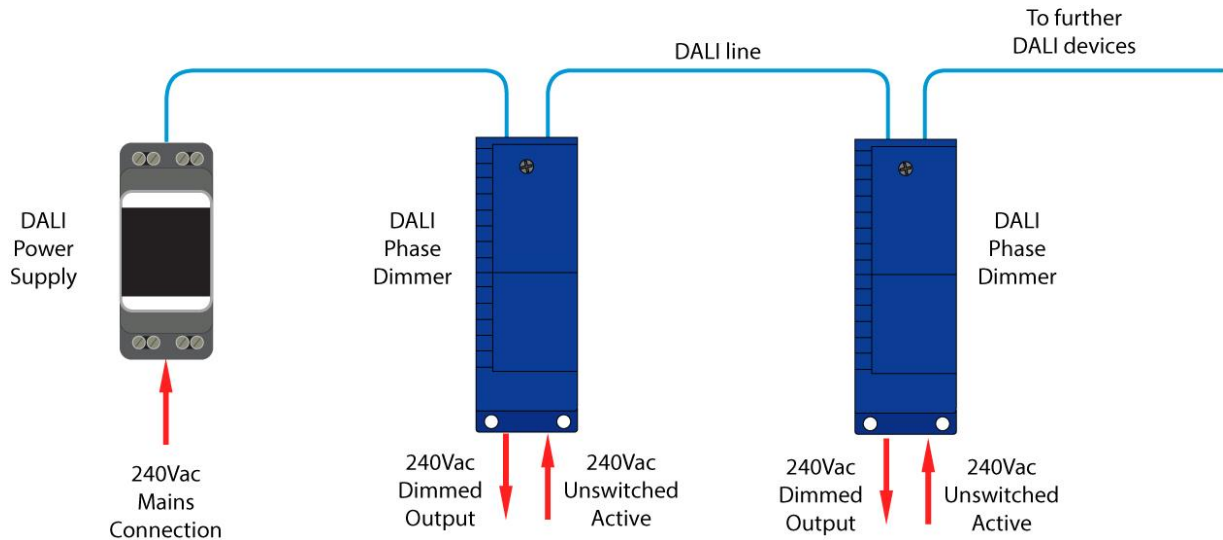

7. Wiring the device



Electric shock may result in serious injury or death. Follow all warnings in this guide and on the product while working in accordance with the latest electrical safety practices.

Connecting the Diginet DALI Adaptive Phase Angle Dimming Device to a DALI line must be carried out by a suitably qualified installer who must work in accordance with standard safety procedures for mains-powered electrical equipment.

DALI Adaptive Phase Angle Dimming Device Connections

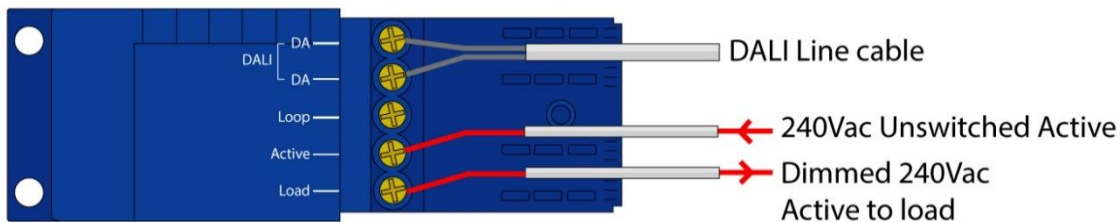

Note

- The dimmed load (Active) output is internally connected via the Active mains supply connection.
- The 'Loop' terminal is not connected internally and can therefore be used to loop unused conductors, such as a Neutral.

Cable entry tabs/knockouts for 1.5mm² and 2.5mm² cables

The terminal cover includes a series of cable entry tabs/knockouts for use with typical 1.5mm² and 2.5mm² Flat TPS/building cable.



Tabs/knockouts for Active, Load and DALI



Tab pushed backwards to accommodate 1.5mm² cable



Tab removed to accommodate 2.5mm² cable

Using cable ties to secure DALI, 240Vac Active and Load cables

The base of the cable termination area in the DALI Adaptive Phase Angle Dimming Device includes a series of slots for cable tying cables, as required. A series of knockouts for cable ties are also provided, should more cable tie locations be required. (Note, four suitable cable ties are included in the packaging).

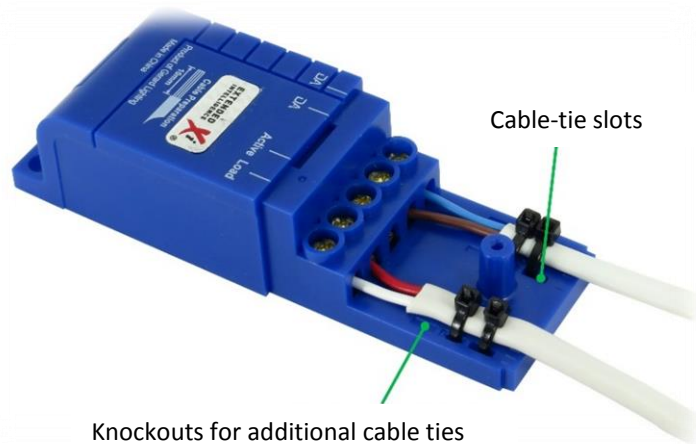

Cable-tie slots

Knockouts for additional cable ties

5-Core modular wiring

The device is suitable for connecting to mains and DALI using 5-core modular wiring cable.

A knockout is provide in the terminal cover to allow the use of circular 5-core cable.



Circular knockout removed to accommodate 5-core modular wiring cable



DALI Adaptive Phase Angle Dimming Device connected to a 5-core cable and modular wiring connector

8. Load Bypass Device

The Dignet Load Bypass Device is designed to provide improved dimming performance of some LED's and CFL's when used in conjunction with Dignet 2-wire dimmer/timer/switch devices. The device overcomes the following issues seen when controlling some LED or CFL light sources:

- When switched off, the LED/CFL lights flicker, pulse on/off or do not switch off completely
- When switching on, the LED/CFL lights have difficulty turning on and the dimmer indicators flicker or pulse.

If one or both of these issues are not experienced with an installation, the load bypass device is not required to be installed.

The Load Bypass Device is installed in parallel with the load, across the switched Active and Neutral, as shown in the diagram below.

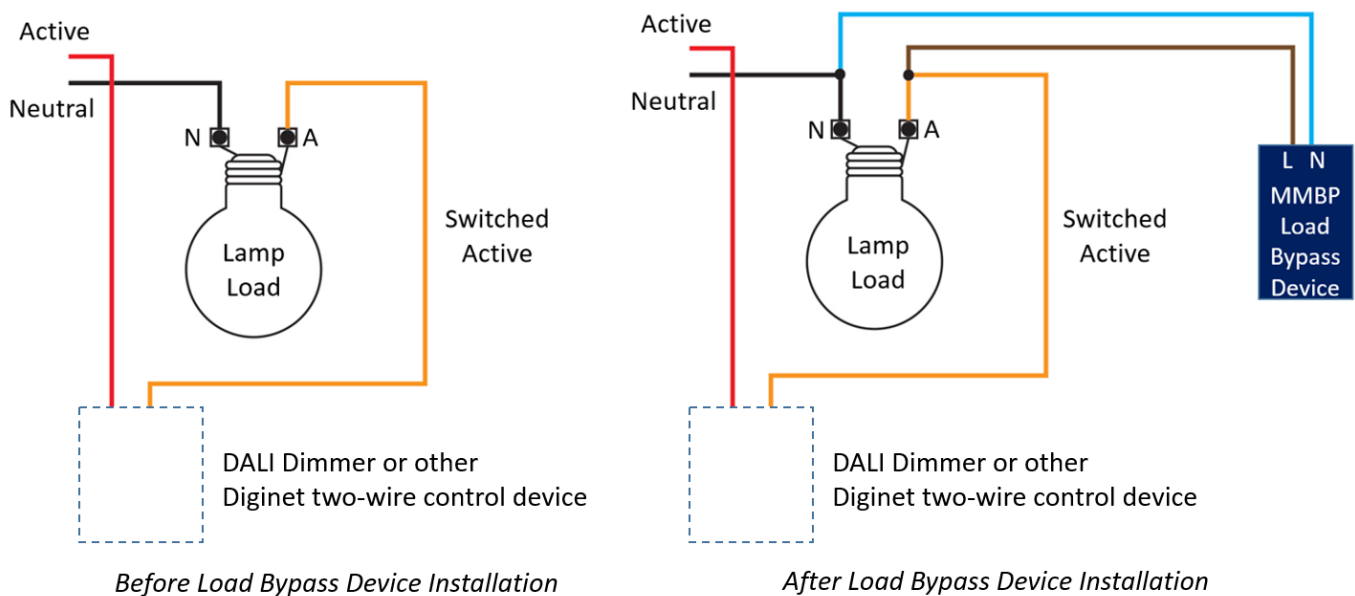

For more detailed information on the use of this product please see the datasheet on the Dignet web site.

www.dignet.net.au

9. Configuring the DALI Adaptive Phase Angle Dimming Device

To operate correctly, the DALI Adaptive Phase Angle Dimming Device must be programmed with the appropriate DALI addressing. Depending on the application of the device, the following parameters may be required to be configured.

- DALI Short Address
- DALI Group Address(s)
- DALI Scene Address(s)
- Minimum Level and Maximum Level
- Power On Level and System Failure Level
- Fade Time and Fade Rate

These parameters can be configured using Dignet **RAPIX Integrator** software, or any other DALI software which allows these standard DALI parameters to be configured in a DALI Compliant Type 4 Phase Dimming Device.

10. Output state on Power-up

When mains power is connected to a DALI Adaptive Phase Angle Dimming Device, by default the output will automatically go to the ON state.

The Power ON state can be changed from the default behaviour via the DALI network using Dignet's **RAPIX Integrator** software or other DALI commissioning software that has the ability to change the DALI standard 'Power ON Level' parameter.

Dignet's **RAPIX Integrator** software supports the ability to set the DALI dimmer *Power On Level* to ON (default), Off or restore to previous level (i.e., level before mains was lost).

This DALI bus-powered control gear follows the System Failure and power Failure operation according to DALI 2 requirements.

11. Output state if DALI communications is lost

If DALI communications is lost to a DALI Adaptive Phase Angle Dimming Device, by default the output will automatically go to the ON state.







The output state when DALI communications is lost can be changed from the default behaviour via the DALI network using Dignet's **RAPIX Integrator** software or other DALI commissioning software that has the ability to change the DALI standard 'System Failure Level' parameter.

Dignet's **RAPIX Integrator** software supports the ability to set the DALI *System Failure Level* state to ON (default), Off or restore to previous level (i.e., level before DALI communications was lost).

12. DALI Adaptive Phase Angle Dimming Device - Product specifications

Number of outputs	1
Nominal Mains Supply Voltage	220 – 240V ac
Mains Frequency Range(s)	47 – 53 Hz
Electrical Isolation	3.75kV (DALI to Mains)
Max. Number of Units on a single DALI line	64
Load Brightness Control Range	0% to 100% (typical for LED loads)
Minimum Load	1W
Current drawn for DALI Line	2mA
Load Rating	See 'Compatible Load Types' on page 8
Standby Power	<100mW
Dimensions	See separate Diagram
Mains Terminals	2 x 2.5mm ² maximum per terminal or 3 x 1.5mm ² maximum per terminal
DALI Terminals	2 x 2.5mm ² maximum per terminal or 3 x 1.5mm ² maximum per terminal
Weight	100g
Operating Temp. Range	0 – 50°C
Operating Humidity Range	10% - 95% RH non condensing
Mounting Arrangement	Surface mount via 6mm mounting holes , DIN rail mounting (with optional DIN rail mounting bracket)
Housing Material type	Flame Retardant Polycarbonate
IP Rating	IP20
Compliance Marks	ROHS, WEEE, CE, RCM, DALI
DALI Device Type	Type 4

13. DALI Adaptive Phase Angle Dimming Device - Compatible Load Types

Load Symbol	Load Type	Maximum Load	Notes
	Dimmable LED Lamps / Drivers	400W	The LED driver must be dimmable. Maximum permitted number of drivers is 400W divided by driver nameplate power rating. Due to variety of LED lamp designs, maximum number of LED lamps is further dependent on power-factor result when connected to dimmer.
	Electronic Transformers	400W	
	Standard Iron-Core Transformers	250W	Due to variety of transformer designs, maximum LV lighting load is further dependent on transformer efficiency.
	Toroidal Iron-Core Transformers	300W	
	Incandescent	350W	
	Dimmable CFLs	400W	Due to variety of CFL designs, maximum number of CFL lamps is dependent on particular CFL make/model.

14. DALI Adaptive Phase Angle Dimming Device - Incompatible Load types

Ceiling Sweep Fans, Exhaust fans and any other motor loads

15. Load Bypass Device - Specifications

Operating Voltage	220-240Vac 50Hz
Power Dissipation	100mW (Note: The device power dissipation is independent of the connected lighting load power)
Max Ambient Temperature	$t_{a\max} = 70^{\circ}\text{C}$
Operating Humidity	10% - 95% RH, non-condensing
Mounting Arrangement	AS/NZS CISPR15:2011 AS/NZS 61347-2-11:2003 IEC 61347-2-11
Dimensions	49mm x 15mm x 11mm
Connection Lead Type	Two core, double insulated, crimped ends Switched Active and Neutral connections
Connection Lead Length	300mm

16.DALI Dimmer dimensions

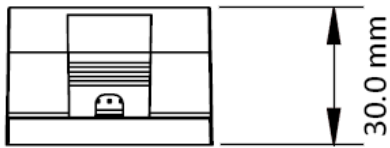
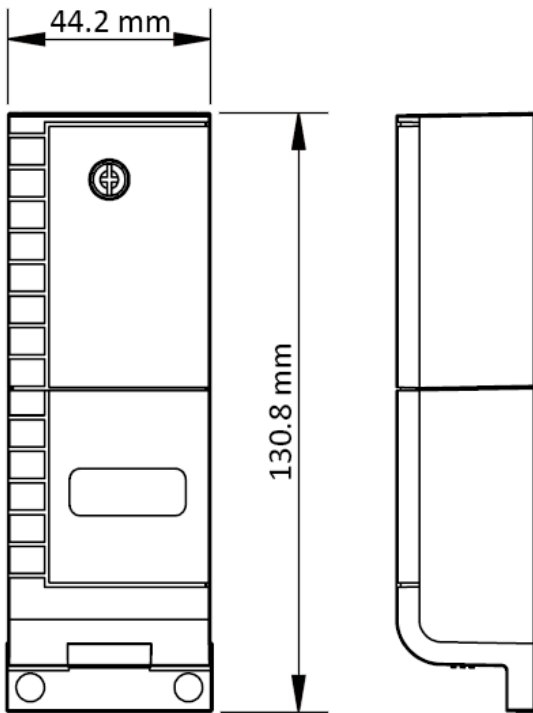

Dimensions – DALI Adaptive Phase Angle Dimming Device

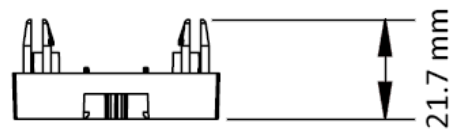
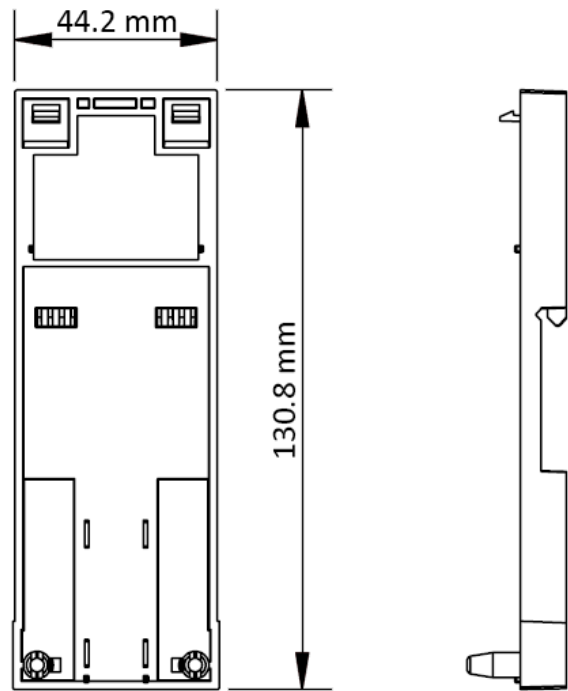

Dimensions – Optional Mounting Bracket

17. Standards and compliance

This DALI Adaptive Phase Angle Dimming Device is designed to meet/exceed the following Australian and International standards.

Australian/New Zealand, Europe & International EMC and Electrical Safety Frameworks and Standards

Regulation	Standard	Title
EMC	EN 55015:2013	Limits and methods of measurement of radio disturbance characteristics of electrical lighting and similar equipment
	IEC 60669-2-1 EN 60669-2-1 AS/NZS 60669.2.1	Switches for household and similar fixed electrical installations - Part 2-1: Particular requirements - Electronic switches. (EMC clauses)
	IEC 61000-3-2, -3 EN 61000-3-2, -3 AS/NZS 61000-3-2, -3	Limits for harmonic current emissions. Limitation of voltage changes, voltage fluctuations and flicker.
	IEC 61000-4-2, -3, -4, -5, -6, -8, -11 EN61547:2009	ESD, Radiated Immunity, EFT/Burst, Surge, Conducted Immunity, Magnetic Immunity, Voltage dips and Short Interruptions.
	AS/NZS CISPR 15	Limits and methods of measurement of radio disturbance characteristics of electrical lighting and similar equipment
Electrical Safety	IEC 60669-1 EN 60669-1 AS/NZS 60669.1	Switches for household and similar fixed-electrical installations - Part 1: General requirements
	IEC 60669-2-1 EN 60669-2-1 AS/NZS 60669.2.1	Switches for household and similar fixed electrical installations - Part 2-1: Particular requirements - Electronic switches

EC Council Directives

The product range is in conformity with the essential requirements of the following EC Directives and accordingly carries the CE marking.

EC Council Directive	Title
2006/95/EC	Low Voltage
2004/108/EC	Electromagnetic Compatibility (EMC)
2011/65/EU	Restriction of Hazardous Substances (RoHS) in Electrical and Electronic Equipment

Other International Directives and Standards

Regulation	Standard	Title
Digital Addressable Lighting Interface (DALI)	IEC 62386-101	Digital Addressable Lighting Interface – Part 101: General Requirements – System
Digital Addressable Lighting Interface (DALI)	IEC 62386-102	Digital Addressable Lighting Interface – Part 102: General Requirements – Control Gear
Digital Addressable Lighting Interface (DALI)	IEC 62386-205	Digital addressable lighting interface - Part 205: Particular requirements for control gear - Supply voltage controller for incandescent lamps (device type 4)

18. Product warranty

This Diginet DALI Adaptive Phase Angle Dimming Device, item number **DGOZ-DM-400W-01** has a two-year warranty against manufacturing defects in accordance with the following terms:

1. Nothing in this Warranty affects any person's rights under the Australian Consumer Law. The benefits to any person under the Gerard Lighting Warranty are in addition to the rights and remedies available under any Consumer Guarantees.
2. Subject to the other clauses of this Warranty, Gerard Lighting warrants that the Goods will be free of manufacturing defects and will perform to Gerard Lighting's specifications.
3. The benefit of the Gerard Lighting Warranty extends only to the owner of the property in which the Goods are installed (the Owner) for two (2) years after the date of purchase (Warranty Period).
4. If within the Warranty Period the Goods fail to perform to Gerard Lighting's specifications as a result of some defect in material or workmanship in the Goods (Defect) then Gerard Lighting will, at its option, repair the Goods or supply replacement Goods free of charge.
5. The Gerard Lighting Warranty will not apply to Goods:
 - 5.1. installed by any person other than a qualified tradesperson; or
 - 5.2. subjected to misuse, neglect, negligence or accidental damage; or
 - 5.3. operated in any way contrary to any operating or maintenance instructions; or
 - 5.4. improperly handled, installed or maintained; or
 - 5.5. altered or modified prior to or after installation.
6. The Gerard Lighting Warranty does not apply to faulty or defective design of Goods unless Gerard Lighting has designed the Goods and Gerard Lighting expressly accepts responsibility for such design in writing.
7. In order to make a claim under the Gerard Lighting Warranty, the Owner must:
 - 7.1. contact Gerard Lighting to obtain a Returned Goods Authorisation Number for the Goods and to be notified of Gerard Lighting's return address for the Goods by:
 - 7.1.1. freecall **1300 95 DALI (3254)**; or
 - 7.1.2. post to **PO Box 314, Padstow NSW 2211**; or
 - 7.1.3. fax to **1300 95 3257**; or
 - 7.1.4. email to sales@diginet.net.au.
 - 7.2. return the Goods at the Owners expense to the return address notified by Gerard Lighting together with all accessories, instructions, specifications or other material supplied with the Goods and a notice in writing:
 - 7.2.1. stating the Returned Goods Authorisation Number for the Goods;
 - 7.2.2. describing in detail the defect or fault in the Goods;
 - 7.2.3. setting out the Owner's contact details (including postal address, email address and telephone numbers at which the Owner can be contacted during usual business hours).
 - 7.3. Gerard Lighting will not accept any returned Goods which have not been returned strictly in accordance with the above instructions.
8. Gerard Lighting will examine any returned Goods and if Gerard Lighting determines that they are defective through no fault of the Owner and are otherwise undamaged, Gerard Lighting will repair or replace the Goods free of charge.
9. Gerard Lighting will notify the Owner whether it accepts the Goods are defective within a reasonable time of return.
10. Gerard Lighting will not be responsible for any costs of de-installation, re-installation, returning Goods or for redelivery of the Goods (whether original or repaired and/or replacement Goods) by Gerard Lighting and any other related expenses of the Owner in claiming under the Gerard Lighting Warranty.
11. Gerard Lighting will not be responsible for any loss or damage to the Goods occurring while the Goods are in transit (either on return to Gerard Lighting or upon redelivery to the Owner of the original or repaired and/or replacement Goods).
12. Gerard Lighting will not be responsible (whether arising in contract or tort (including negligence) or under any statute) for any special, indirect, incidental, consequential or economic losses or damages (including loss of data, business, profits, revenue, anticipated savings, bargain, opportunity or goodwill) whether or not the possibility of those losses or damages being suffered had been brought to the attention of Gerard Lighting.

The Australian Consumer Law requires the inclusion of the following statement with the Gerard Lighting Warranty:

Our goods come with guarantees that cannot be excluded under the Australian Consumer Law. You are entitled to a replacement or refund for a major failure and for compensation for any other reasonably foreseeable loss or damage. You are also entitled to have the goods repaired or replaced if the goods fail to be of acceptable quality and the failure does not amount to a major failure.

Gerard Lighting Pty Ltd (Gerard Lighting) reserves the right to alter the specifications, designs or other features of any items and to discontinue any items at any time without notice and without liability. While every effort is made to ensure that all information in this user and installation guide is correct, no warranty of accuracy is given and Gerard Lighting shall not be liable for any error.

Trademarks

The identified trademarks and copyrights are the property of Gerard Lighting unless otherwise noted.

© Copyright

This user and installation guide is copyright to Gerard Lighting. Except as permitted under relevant law, no part of this user and installation guide may be reproduced by any process without written permission of and acknowledgement to Gerard Lighting.

Diginet is a brand of Gerard Lighting.

October 2016

Printed on recycled paper

DIGINET.NET.AU

Product of Gerard Lighting Pty Ltd

ABN – 89 095 788 864

96-112 Gow Street

Padstow NSW 2211

Contact

General Enquiries: 1300 95 DALI (3254) or sales@diginet.net.au

Technical Services: 1300 95 3244 or support@diginet.net.au

Fax: 1300 95 3257

Diginet is a brand of Gerard Lighting